

SERIES L25

DESIGNED FOR LED_s

Snap-in Durayl® LED Acrylic Diffuser

Indirect Uplight or Wall Wash

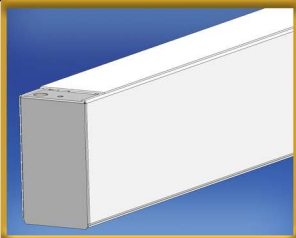

Wall Mount Bracket Allows Vertical Surface Mounting

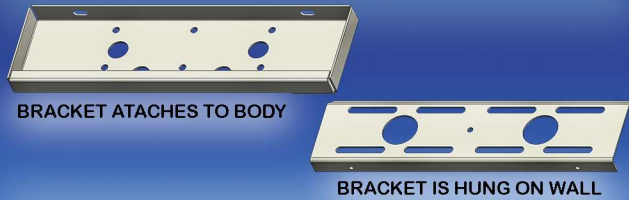

Joiner Band/Support Bracket Allows Continuous Runs



Application

- Direct/Indirect Lighting
- Pendant/Suspended
- Wall Mount

Features

- 4' (46" 48"), 8' (92" 96") Standard Lengths
- Custom lengths available upon request
- Contact AMP if using continuous runs
- Welded end caps, joiner brackets, and internal supports

Finishes

- Bare (customer to source local finishing)
- Post-powder coat - contact AMP
- Internal cover & gear tray available in P.P.W. or Mill finish aluminum

LED & Lamping

- LED Boards (1 or 2 row per length)
- T5 (1 or 2 lamp per length)
- T5 is eligible for retro kit rebate programs

LED/LAMPING	
LED BOARDS	LED T5
4' (46" or 48")	4' (46") 1 or 2 lamps
8' (92" or 96")	8' (92") 2 or 4 lamps (T)

(T) Tandem

Specifications subject to change without notice.



Adam Metal Products Company • P.O. Box 450 • Ledgewood, NJ • 07852
Phone: 973.770-1100 • Fax 973.770-1105 • www.adammetal.com



SERIES L25

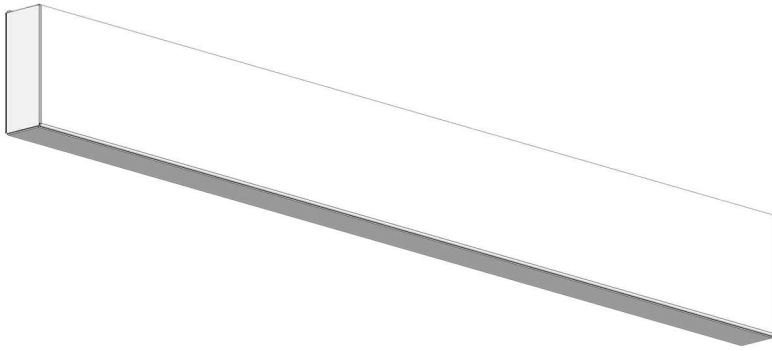

TOP VIEW (UPLIGHT)

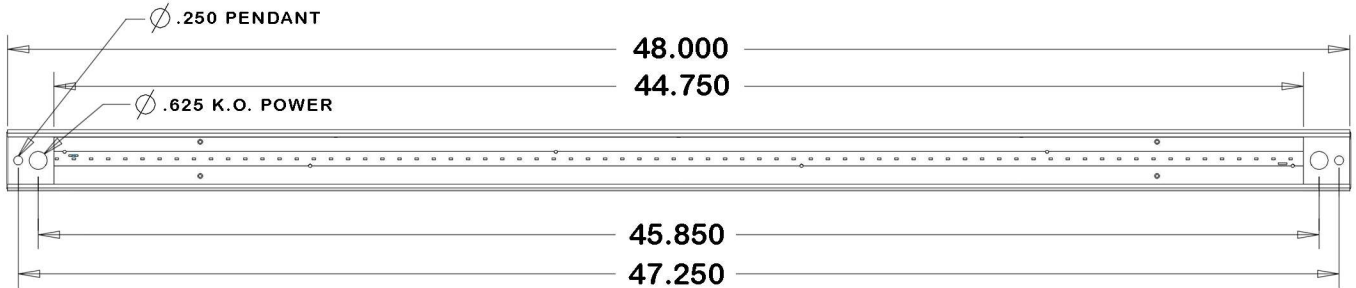

SIDE VIEW

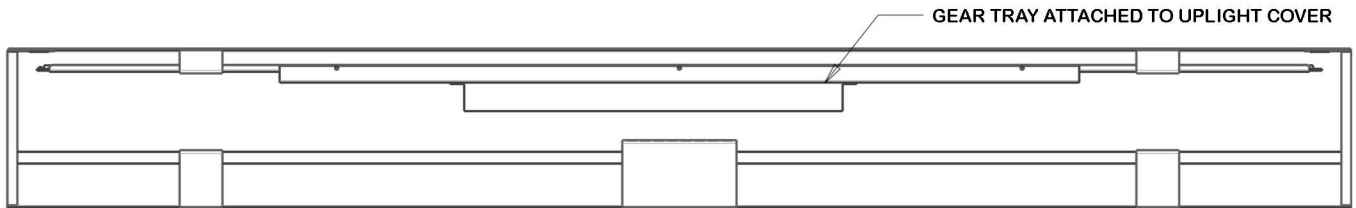

BOTTOM VIEW (DOWNLIGHT)

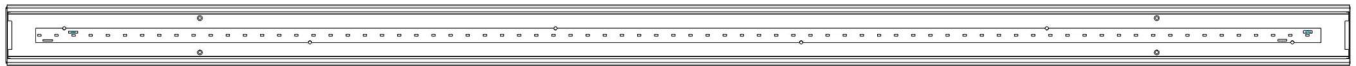

END VIEW

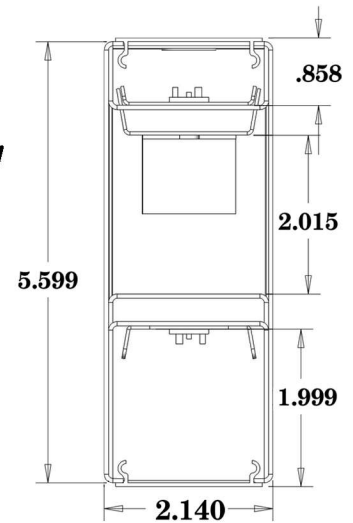

LED/LAMPING		
LED BOARDS	LED T5	LED T8
4' (46" or 48")	4' (46") 1 or 2 lamps	4' (48") 1 or 2 lamps
8' (92" or 96")	8' (92") 2 or 4 lamps (T)	8' (96") 2 or 4 lamps (T)

(T) Tandem

Specifications subject to change without notice.
Rev 2-26-2020



Adam Metal Products Company • P.O. Box 450 • Ledgewood, NJ • 07852
Phone: 973.770-1100 • Fax 973.770-1105 • www.adammetal.com

